

## DALI-2+Push DT6 Dimmable LED Driver



### Product Introduction

JISIM JD3132 is a constant-current LED intelligent dimmable driver, specifically designed for indoor high-power lighting fixtures. It supports DALI dimming and color temperature adjustment functions, and its customized dimming curve offers a more comfortable viewing experience for the human eyes. When not connected to external signals, it can be used as a non-dimmable driver. It is suitable for LED downlights, LED linear lights, and LED panel lights, and is widely applied in projects such as smart homes, smart hotels, intelligent commercial lighting, smart offices, smart buildings, and large public facilities, when paired with intelligent control systems.



### Product Features

- Compact SELV independent Dimmable Driver
- Support DALI-2+PushDim
- Input 100-240V~, Global Certification
- Suitable for Class I / II / III indoor light fixtures.
- Smooth dimming, flicker-free, dimming range 0.1-100%
- Small size and light weight, High power factor, High Efficiency, Low THD
- Standby power consumption < 0.5 W, meets ErP energy efficiency certification
- The housing is made from V0 flame retardant PC materials from CHIMEI
- DIP switch for multi-current setting, Max. output power 40W
- Up to 50000 hours life time, 5-Year Warranty (Long-lasting Capacitor)

### Technical Specifications (All parameters not specially mentioned are measured at 230VAC input, full load and 25°C of ambient temperature)

Model		JD3123		
Features	Output Type	Constant Current		
	Dimming Interface	DALI-2 DT6(IEC62386-101-102-207)		
	Output Feature	Isolation		
	IP Rating	IP20		
Output	Insulation Rating	Class II (Suitable for class I / II / III light fixtures)		
	No Load Output Voltage	≤59Vdc		
	Output Voltage Range	15-40Vdc		
	Output Current Range	700-1050mA		
	Output Power Range	9.45W-40W		
	Dimming Range	0.1~100%		
	Ripple Current	<5%		
	Current Accuracy	±5%		
Input	PWM Frequency	1000Hz		
	DC Voltage Range	120-300Vdc		
	AC Voltage Range	100-240Vac		
	Rated Voltage	115Vac/230Vac		
	Input Frequency	50/60Hz		
	Input Current	≤0.6A/115Vac, at full load	≤0.3A/230Vac, at full load	
	Input Power	Max.46W		
	Power Factor	PF>0.95/115Vac, at full load	PF>0.9C/230Vac, at full load	
	THD	THD<10%/230Vac, at full load		
	Efficiency	≥87%, at full load		
	Inrush Current	Cold start 25A (Test twidth=102us under 50% Ipeak@230Vac)		
Environment	Anti-Surge	L-N:1KV		
	Leakage Current	<0.5mA/230Vac		
	Working Temperature	Ta:-20°C~45°C		
	Working Humidity	20~95%RH(no condensation)		
	Storage Temperature/Humidity	-20~85°C/10~95%RH		
Protection	Case Temperature	Tc:90°C		
	Life Time	>50000h@TC=75°C		
	Overload Protection	Hiccup Mode (Auto-Recovery after Elimination)		
Safety & EMC	Open Circuit Protection	≤59Vdc		
	Short Circuit Protection	Hiccup Mode (Auto-Recovery after Elimination)		
Safety & EMC	Withstand Voltage	I/P-O/P:3750Vac,I/P-DIM: 3750Vac,O/P-DIM:1500Vac,<5 mA,60S		
	Insulation Resistance	I/P-O/P:100MΩ/500VDC/25°C/70%RH		
	Safety Standards	CCC	China	GB19510.1, GB19510.14
		CE	European Union	EN61347-1, EN61347-2-13, EN62493
		KC	Korea	KC61347-1, KC61347-2-13
		TUV	Germany	EN61347-1, EN61347-2-13, EN62493
		ENEC	Europe	EN61347-1, EN61347-2-13, EN IEC62384
		CB	CB Member States	IEC61347-1, IEC61347-2-13
		RCM	Australia	AS/NZS61347.1, AS61347.2.13
		BIS	India	IS15885(PART2/SEC13)
		EAC	Russia	IEC61347-1, IEC61347-2-13
		UKCA	United Kingdom	BS EN61347-1, BS EN IEC61347-2-13, BS EN62493
	EMC Emission	CCC	China	GB/T17743, GB17625.1
		CE	European Union	EN IEC55015, EN IEC61000-3-2, EN61000-3-3
		KC	Korea	KSC9815, KSC9547
RCM		Australia	EN IEC55015, EN IEC61000-3-2, EN61000-3-3	
UKCA		United Kingdom	BS EN IEC55015, BS EN IEC6100-3-2, BS EN61000-3-3	
EAC		Russia	IEC62493, IEC61547, EN55015, IEC61000-3-2, IEC61000-3-3	
EMC Immunity	BIS	India	IS15885(PART2/SEC13)	
	EN61000-4-2,3,4,5,6,8,11,EN61547			
ErP	Power Consumption	Standby power consumption	<0.5W (PWM off)	
	Flicker/Stroboscopic Effect	IEEE1789	Meet IEEE Std1789-2015	
	DF	CIESVM	Pst≤1, SVM≤0.4	
		Phase factor	DF≥0.9	

DALI-2+Push DT6 Dimmable LED Driver

LED Current Settings

Number	Output				Switch Position		
	Current (mA)	Voltage (VDC)	No Load Output Voltage (VDC)	Power (W)	1	2	3
*1	700	9-40	59	28	/	/	/
2	750	9-40		30	ON	/	/
3	800	9-40		32	/	ON	/
4	850	9-40		34	ON	ON	/
5	900	9-40		36	/	/	ON
6	950	9-40		38	ON	/	ON
7	1000	9-40		40	/	ON	ON
8	1050	9-38		40	ON	ON	ON

\* Factory default.

Please disconnect the AC input before adjusting the output current via the DIP switch, If not, it may damage the lighting fixture. No Overload, The output power should be less than or equal to 40W.

2D Diagram

Length (L)	Width (D)	Height (H)	Weight
165mm	42mm	30mm	208±10g

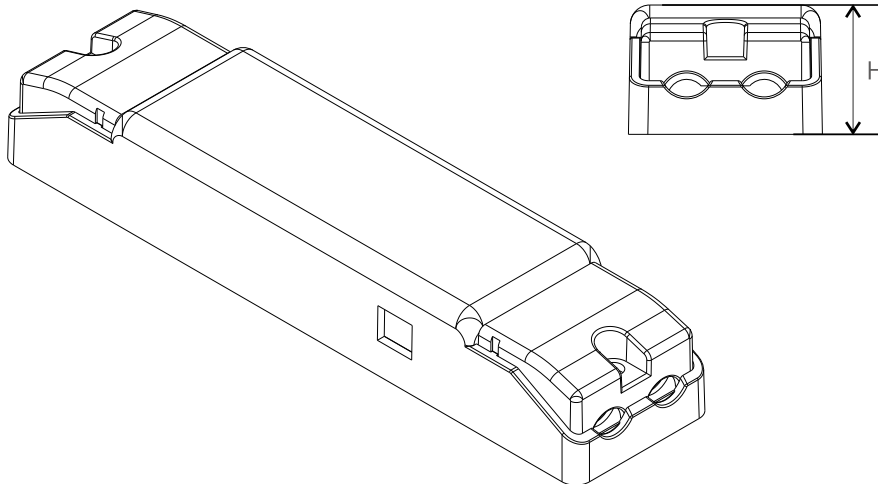
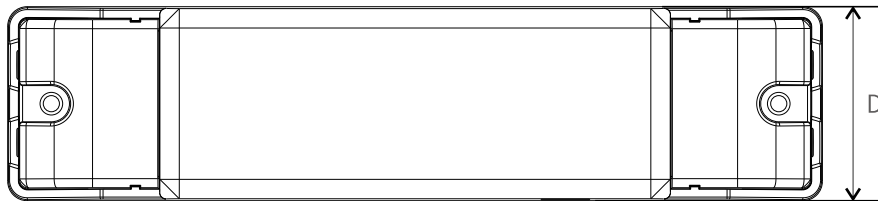
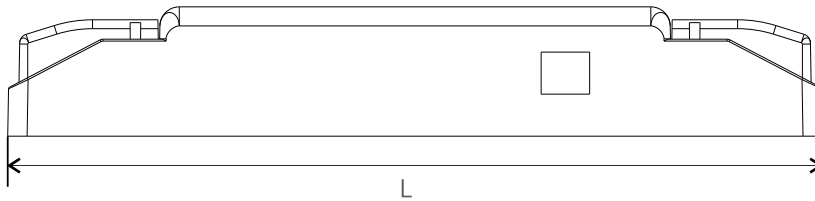

# DALI-2+Push DT6 Dimmable LED Driver

## Wiring Diagram

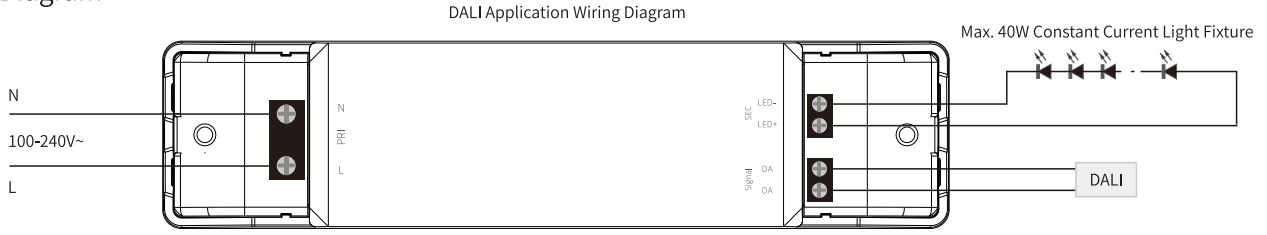

- The two DALI control lines polarity-reversible.
- Default setting brightness is 100%.
- The default is logarithmic dimming curve.
- Max. 64 DALI drivers per DALI control line.
- The configuration parameters of the driver can be set through the DALI configuration tool or DALI application controller during installation, such as setting device address, group address, power-on level, bus-failure level, scene level, fade time, dimming curve, etc.
- The current consumption of the DALI interface is less than 2mA.
- The maximum distance length of the DALI control line is 200m at 2x1.0mm<sup>2</sup>.
- DALI bus can be wired together with any mains voltage cables, but separate wiring is recommended.
- Max. 64 DALI drivers per DALI control line. DALI protocol includes Max. 16 scene groups and 16 scenes.

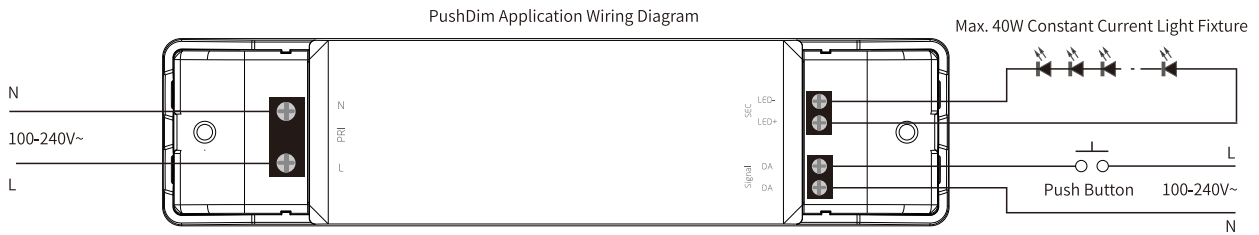

Long press: Adjust brightness, short press: Turn on/off.

## Installation Instructions

Interface	Marking	Description	Wire cross section	Wire Stripping Length
Input	L	Input terminal of AC live wire	0.75...1.5mm <sup>2</sup> (16-18AWG)	5...6mm
	N	Input terminal of AC neutral wire	0.75...1.5mm <sup>2</sup> (16-18AWG)	5...6mm
Output	LED+	Positive electrode output of the driver	0.5...1.0mm <sup>2</sup> (16-20AWG)	5...6mm
	LED-	Negative electrode output of the driver	0.5...1.0mm <sup>2</sup> (16-20AWG)	5...6mm
Signal	DA	DALI dimming input	0.4...1.0mm <sup>2</sup> (16-20AWG)	5...6mm
	DA	DALI dimming input	0.4...1.0mm <sup>2</sup> (16-20AWG)	5...6mm

- Connection Instructions:
1. Rated torque: M2.6, 0.35-0.40N.m
  2. All connections must be as short as possible to ensure good EMI performance.
  3. No secondary switches are allowed
  4. Incorrect wiring can damage the LED

## Product Characteristic Curves

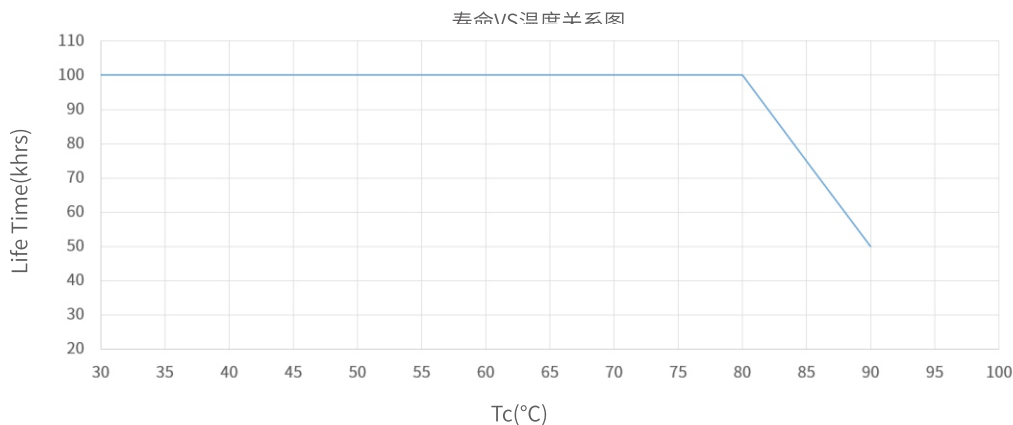

The life-time of the LED driver is shown in the figure above calculated based on the 90% survival rate). The relation of t<sub>c</sub> to t<sub>a</sub> temperature depends also on the luminaire design.

DALI-2+Push DT6 Dimmable LED Driver

Operating Window

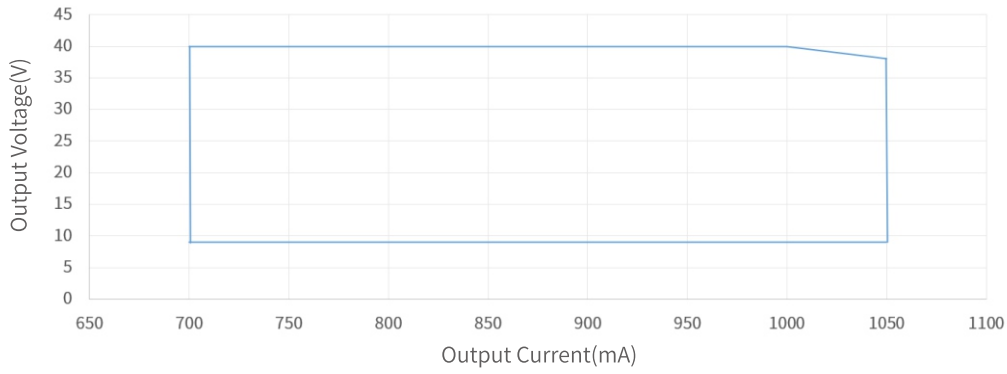

Power Factor VS @Load 230Vac

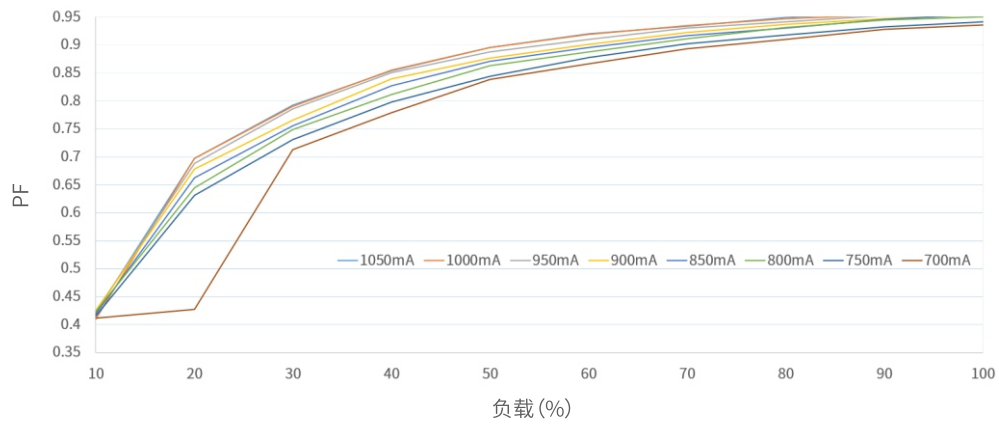

THD VS Load @230Vac

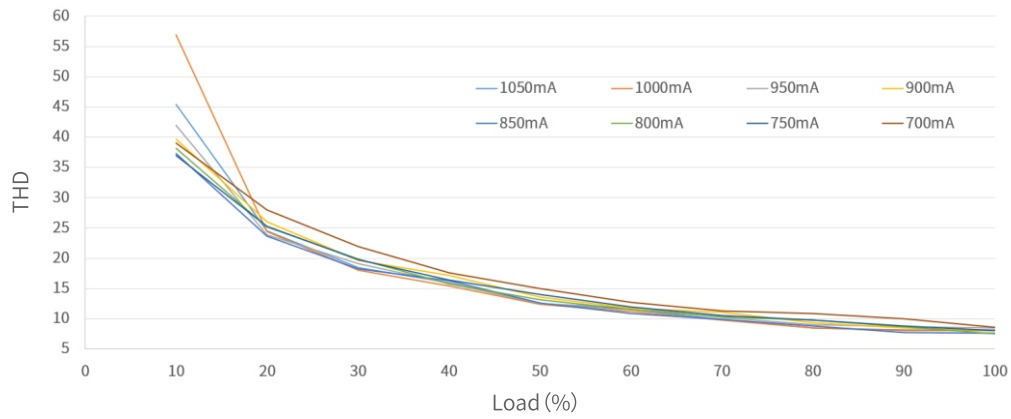

Efficiency VS Load@230Vac

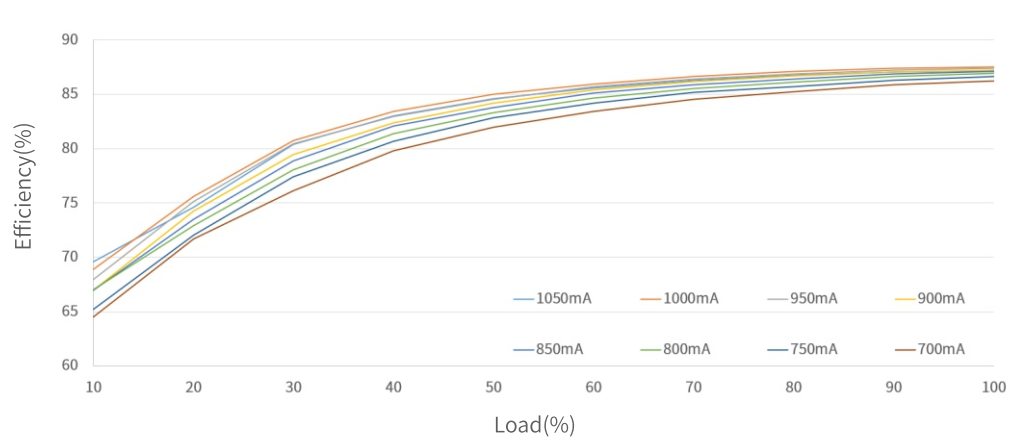

## DALI-2+Push DT6 Dimmable LED Driver

### Packaging Image



Inner Packaging Box



Small Carton Packaging



Large Carton Packaging

Packaging details	Carton size	Packing units	Weight
Inner Packaging Box	168 x 47 x 34mm	1pcs	225±10g
Small Carton Packaging	350 x 197 x 167mm	30pcs	7kg
Large Carton Packaging	420 x 360 x 365mm	120pcs	28.5kg

**Packaging instructions:**

Each large carton packaging contains 4 small carton packagings, Each small carton packaging contains 30 inner packaging boxes.

### Cautions

- This product is used as a component in conjunction with a lighting fixture. Due to the influence of EMC from the lighting fixture and wiring, customers should perform EMC testing to confirm the entire product set.
- No operation with power on. Installation and debugging should be performed by qualified professionals. Please read the product manual carefully before installation.
- This product can only be used outside the light body, Cannot be used inside of the light, and it must be used within the specified working environment.
- This product is not waterproof and should be avoided from direct sunlight and rain. If it is installed outdoors, please use a waterproof case.
- Good heat dissipation conditions are beneficial to the product's lifetime. Please install the product in a suitable environment, and strictly prohibit using double-sided tape to attach the casing or circuit board.
- Please check the parameters of the LED driver to ensure they meet the application requirements of the lighting fixture.
- Please install according to the standard wire gauge specified in the manual to avoid malfunctions caused by inappropriate wiring.
- Before powering on, please ensure that the wiring is correct to prevent damage to the driver or lighting fixture caused by incorrect wiring.
- If a malfunction occurs, please do not attempt to repair it yourself; if you have any questions, please contact the manufacturer.
- The manual is for reference only. Please refer to the actual product. Any changes to this product will not be notified separately.
- For more information, please send an email to fei.l@jisim-tech.com.

### Warranty Terms

- The product is warranted for 5 years. (The life and MTBF of the product are for reference only, and do not represent a warranty statement.)
- During the warranty period, if any quality issues arise, JISIM will provide free repair or replacement services.

### Non-Warranty Terms

- The following situations are not covered by the free warranty or replacement service:
- The warranty period has expired.
  - Damage caused by human factors such as overvoltage, overload, or improper operation.
  - Deformation or damage to the exterior appearance.
  - Damage caused by natural disasters or other irresistible human factors.
  - The warranty label has been torn off or removed.
  - No contract or invoice proof is provided.

1. Repair or replacement provided is the only remedy for customers. JISIM is not liable for any incidental or consequential damage unless it is within the law.
2. JISIM has the right to amend or adjust the terms of this warranty, and release in written form shall prevail.

