

Product introduction >>>>

JISIM JD2137 is a 15W constant current LED intelligent dimmable driver specifically designed for small aperture luminaires. It supports deep dimming functions such as 0-10V, 1-10V, 10V PWM, and RX. The customized dimming curve provides a more comfortable viewing experience for the human eye. When not connected to an external signal, it can be used as a non-dimmable driver. It is suitable for small aperture downlights, spotlights, linear lights. Paired with various intelligent control systems, it is widely used in smart homes, smart hotels, intelligent commercial spaces, smart offices, smart buildings, and other facilities.



Product Features >>>>

- Compact SELV independent dimmable driver
- Support 0/1-10V PWM RX dimming
- Global certification, SELV equivalent
- Suitable for Class I / II / III indoor light fixtures
- Smooth dimming, flicker-free, dimming range: 0.1-100%
- DIP switch for multi-current setting, Max. output power 15W
- Up to 50000 hours life time, 5-Year warranty (Long-lasting Capacitor)
- Small size and light weight, High power factor, High efficiency, Low THD
- The housing is made from V0 flame retardant PC materials from CHIMEI

Technical Specifications (All parameters not specially mentioned are measured at 230V-50Hz input, full load and 25°C of ambient temperature) >>>>

Model	JD2137						
Input	DC Voltage Range	220-240V		Features	Output Type	Constant Current	
	AC Voltage Range	220-240V			Dimming Interface	1-CH 0-10V/1-10V_RX_PWM	
	Rated Voltage	220Vac/230Vac/240Vac			Output Feature	Isolation	
	Input Frequency	0/50/60Hz			IP Rating	IP20	
	Input Current	≤0.2A/230Vac(at full load)			Insulation Rating	Class II (Suitable for class I II III light fixtures)	
	Input Power	Max.18.5W		Output	No Load Output Voltage	≤59Vdc	
	Efficiency	≥82%(at full load)			Output Voltage Range	9-40Vdc	
	Inrush Current	Cold start 15A(Test twidth=102us under 50% Ipeak@230Vac)			Output Current Range	150-500mA	
	Leakage Current	<0.5mA/230Vac			Output Power Range	1.35-15W	
Protection	Overload Protection	Hiccup Mode (Auto-Recovery after Elimination)			Dimming Range	0.1~100%	
	Open Circuit Protection	≤59Vdc			Ripple Current	<5%	
	Short Circuit Protection	Hiccup Mode (Auto-Recovery after Elimination)		Current Accuracy	±5%		
ErP	Flicker/ Stroboscopic Effect	IEEE1789	Meet IEEE Std1789-2015	Environment	PWM Frequency	<6000Hz	
		CIESVM	Pst≤1, SVM≤0.4		Working Temperature	ta:-20°C~60°C	
Test Equipment	AC Source	PS-61005			Working Humidity	20~95%RH(No Condensation)	
	DC Electronic Load	IT8512A+			Storage Temperature/Humidity	-20~85°C/10~95%RH	
	Spectrum Analyzer	KH3932		Case Temperature	tc:75°C		
	Surge Generator	SUG61005TB(7.5KV)-2216		Life Time	>50000h@tc=75°C		
	Stroboscope	LANSHU-201B		Withstand Voltage Tester	TH9302D		
				Thermostatic Humidity Chamber	HT-H-802		
				Intelligent Electrical Parameter Meter	PF9800		
				Oscilloscope	TBS1102B		
				Digital Wattmeter	PM2818C		
					Other		
					LED Load		

LED Current Settings >>>>

Number	Output				Switch Position		
	Current (mA)	Voltage (VDC)	NO Load Output Voltage (VDC)	Power (W)	1	2	3
*1	150	9-40	59	6	/	/	/
2	200	9-40		8	ON	/	/
3	250	9-40		10	/	ON	/
4	300	9-40		12	ON	ON	/
5	350	9-40		14	/	/	ON
6	400	9-36		14.4	ON	/	ON
7	450	9-33		14.9	/	ON	ON
8	500	9-30		15	ON	ON	ON

◀ * Factory default.

1. Please disconnect the AC input before adjusting the output current via the DIP switch, if not, it may damage the lighting fixture.

2. No Overload, The output power should be less than or equal to 15W.

0/1-10V PWM RX Dimmable LED Driver

2D Diagram

Length (L)	Width (D)	Heigh (H)	Weight (W)
126mm	30mm	20mm	67±10g

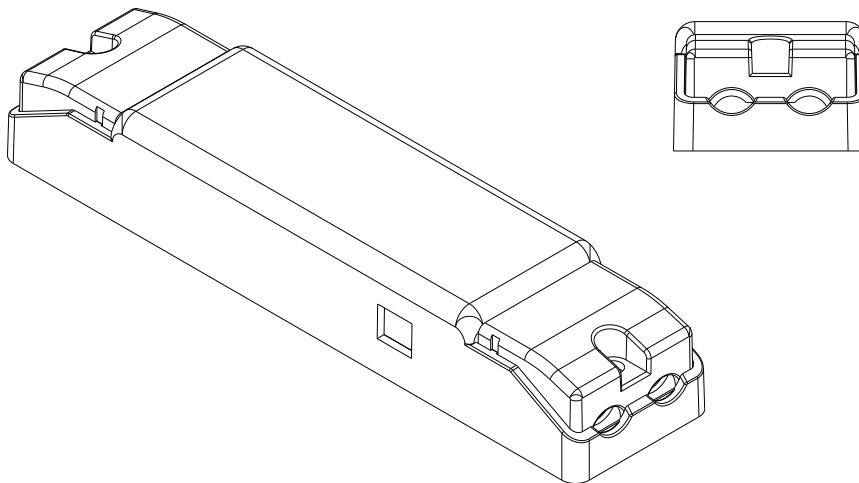
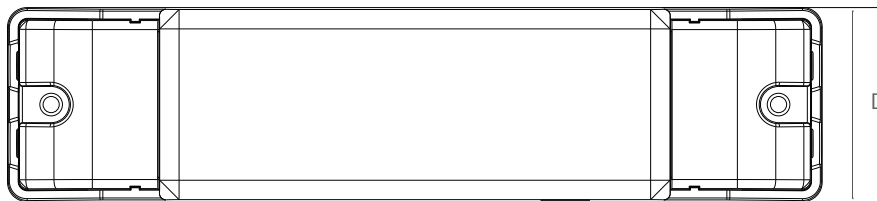

Wiring Diagram

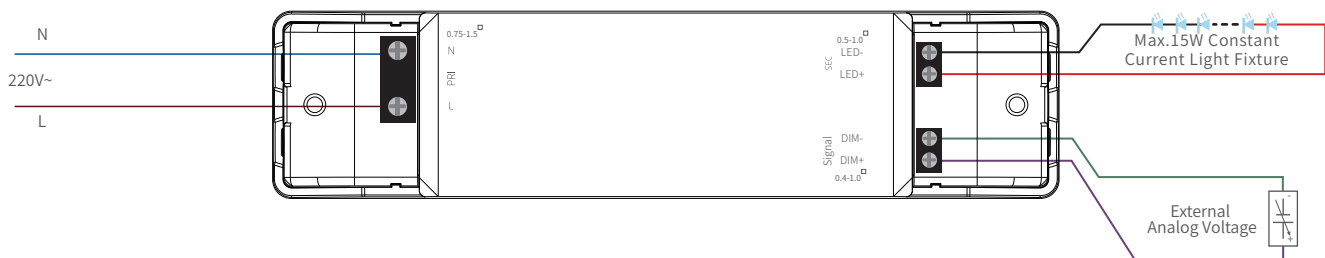

◦ Explanation of 0/1-10V Interface Signals ◦

- ◀ The DIM+ terminal is used to adjust brightness:
 - When the voltage at the DIM+ terminal is adjusted within the range of 0/1-10V, the brightness changes from 0 to 100%.The light turns on/off at a voltage value of $1.1 \pm 0.05V$.
 - When DIM+ terminals is left floating (unconnected), the default output is 100% Brightness.

0/1-10V PWM RX Dimmable LED Driver

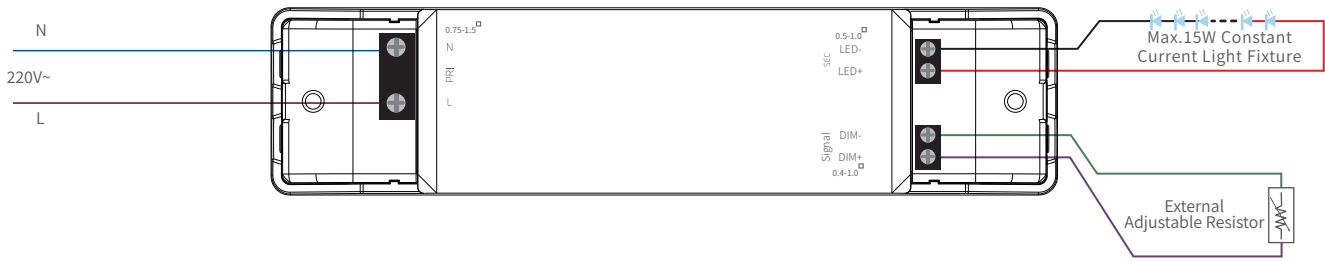

◦ Potentiometer (Rx) Interface Signal Description ◦

◀ The DIM+ terminal is used for adjusting brightness:

When the resistance value at the DIM+ terminal is adjusted within 0-100KΩ, the brightness changes from 0 to 100%. Specifically, a resistance value of $3K\Omega \pm 1K\Omega$ triggers the light to turn on/off.

When DIM+ terminals is left floating (unconnected), the default outputs 100% Brightness.

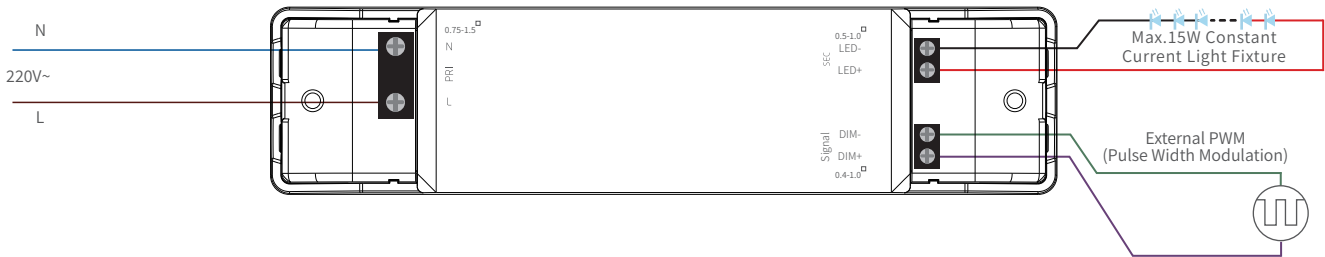

◦ PWM Interface Signal Description ◦

◀ The DIM+ terminal is used for adjusting brightness:

When the 10V PWM signal at the DIM+ terminal is adjusted from 0 to 100%, the brightness changes correspondingly from 0 to 100%.

When DIM+ terminals is left floating (unconnected), the default output is 100% cool Brightness.

Installation Instructions

Interface	Marking	Description	wire cross Section	wire Stripping Length
Input	N	Input terminal of AC neutral wire	0.75...1.5mm ² (16-18AWG)	5...6mm
	L	Input terminal of AC live wire	0.75...1.5mm ² (16-18AWG)	5...6mm
Output	LED-	Negative electrode output of the driver	0.5...1.0mm ² (17-20AWG)	5...6mm
	LED+	Positive electrode output of the driver	0.5...1.0mm ² (17-20AWG)	5...6mm
Signal	DIM-	Negative electrode input 0-10V/PWM/RX dimming	0.4...1.0mm ² (17-21AWG)	5...6mm
	DIM+	Positive electrode input 0-10V/PWM/RX dimming	0.4...1.0mm ² (17-21AWG)	5...6mm

◦ Connection instructions ◦

1. Before connecting the input terminals, adjust the torque of the electric screwdriver to 0.35-0.4 N·m;
before connecting the output terminals, adjust the torque of the electric screwdriver to 0.15-0.2 N·m.
2. All connections must be as short as possible to ensure good EMI performance.
3. No secondary switches are allowed.
4. The driver output does not support hot swap
5. Incorrect wiring can damage the LED.
6. The power cable should be kept at a certain distance from the driver and other connecting cables (5-10cm recommended)

Installation Precautions

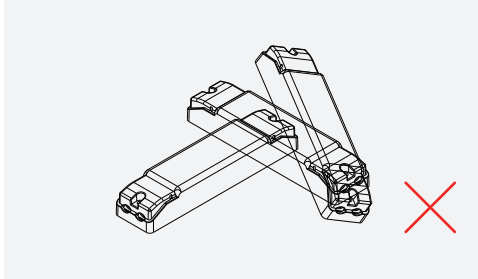

Do not stack the products. The distance between adjacent products should be more than 5 cm to avoid affecting the heat dissipation and service life of the products.

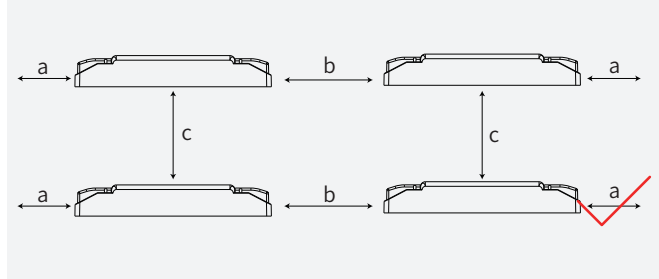

dimensions for safe installation should be: $a > 5\text{cm}$; $b > 5\text{cm}$; $c > 5\text{cm}$

Product Characteristic Curves

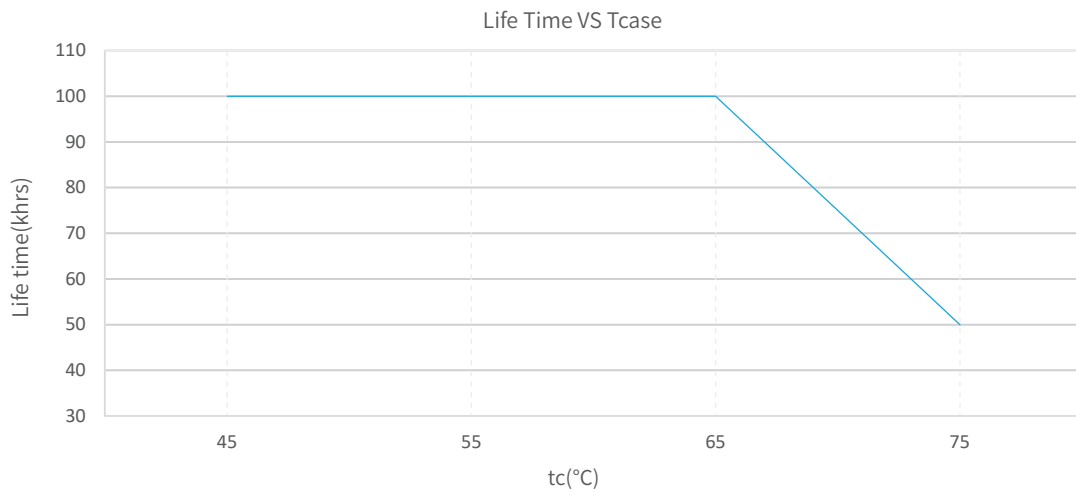

The life-time of the LED driver is shown in the figure above calculated (based on the $t_c:75^\circ\text{C}$ survival rate). The relation of t_c to t_a temperature depends also on the luminaire design.

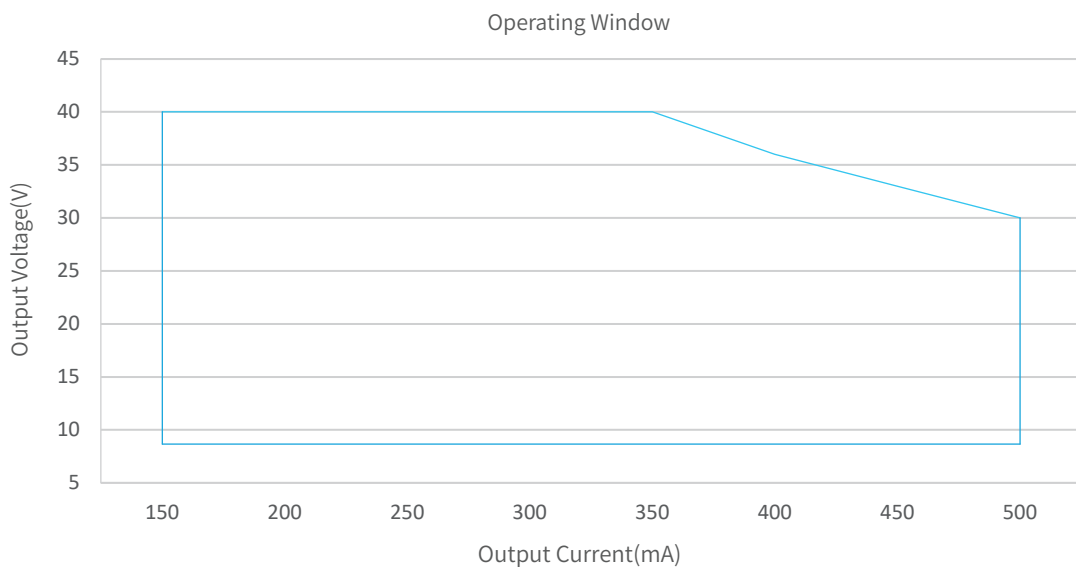

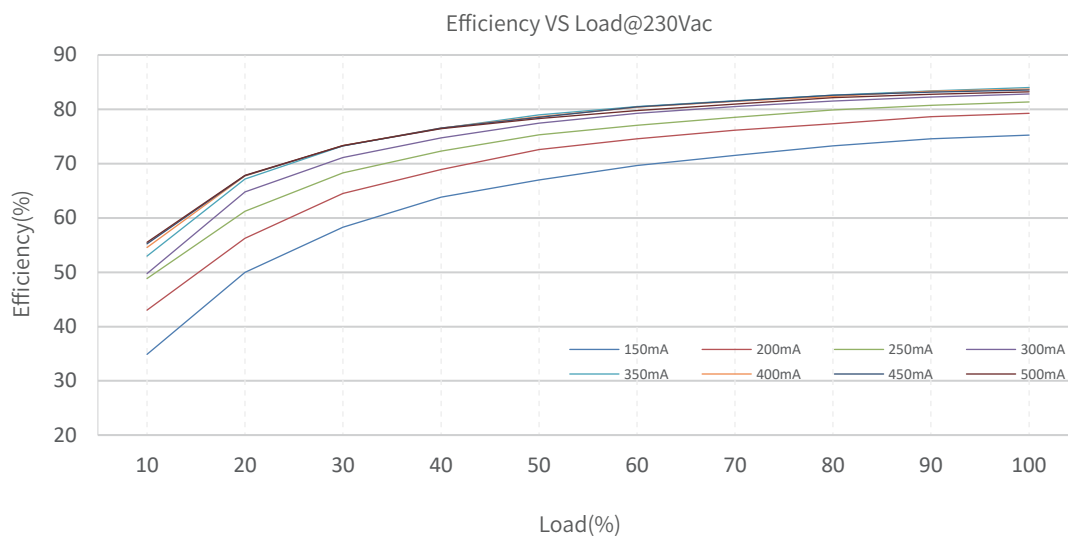

Packaging Image



Packaging Size

Packaging Details	Carton Size	Packing Units	Weight
Inner Packaging Box	140x33x23mm	1pcs	78.2±10g
Small Carton Packaging	350 x 197 x 167mm	80pcs	6.56kg
Large Carton Packaging	420 x 360 x 365mm	320pcs	27.1kg

Packaging instructions:

Each large carton packaging contains 4 small carton packagings, Each small carton packaging contains 80 inner packaging boxes.

0/1-10V PWM RX Dimmable LED Driver

Cautions

- ▶ This product is used as a component in conjunction with a lighting fixture. Due to the influence of EMC from the lighting fixture and wiring, customers should perform EMC testing to confirm the entire product set.
- ▶ No operation with power on. Installation and debugging should be performed by qualified professionals. Please read the product manual carefully before installation.
- ▶ This product can only be used outside the light body, cannot be used inside of the light, and it must be used within the specified working environment.
- ▶ This product is not waterproof and should be avoided from direct sunlight and rain. If installed outdoors, please use a waterproof case.
- ▶ Good heat dissipation conditions are beneficial to the product's lifetime. Please install the product in a suitable environment, and strictly prohibit using double-sided tape to attach the casing or circuit board.
- ▶ Please check the parameters of the LED driver to ensure they meet the application requirements of the lighting fixture.
- ▶ Please install according to the standard wire gauge specified in the manual to avoid malfunctions caused by inappropriate wiring.
- ▶ Before powering on, please ensure that the wiring is correct to prevent damage to the driver or lighting fixture caused by incorrect wiring.
- ▶ If a malfunction occurs, please do not attempt to repair it yourself; if you have any questions, please contact the manufacturer.
- ▶ The manual is for reference only. Please refer to the actual product. Any changes to this product will not be notified separately.
- ▶ For more information, please send an email to fei.l@jisim-tech.com.

Warranty Terms

- ▶ The product is warranted for 5 years. (The life and MTBF of the product are for reference only, and do not represent a warranty statement.)
- ▶ During the warranty period, if any quality issues arise, JISIM will provide free repair or replacement services.

Non-Warranty Terms

The following situations are not covered by the free warranty or replacement service:

- ▶ The warranty period has expired.
- ▶ Damage caused by human factors such as overvoltage, overload, or improper operation.
- ▶ Deformation or damage to the exterior appearance.
- ▶ Damage caused by natural disasters or other irresistible human factors.
- ▶ The warranty label has been torn off or removed.
- ▶ No contract or invoice proof is provided.



Notice:

1. Repair or replacement provided is the only remedy for customers. JISIM is not liable for any incidental or consequential damage unless it is within the law.
2. JISIM has the right to amend or adjust the terms of this warranty, and release in written form shall prevail.